

AEE 2021

by Sri Mawar Said

Submission date: 26-Sep-2022 03:15AM (UTC-0400)

Submission ID: 1909236517

File name: art01_corr.pdf (3.49M)

Word count: 3963

Character count: 20339

Prediction of lightning density value tower based on Adaptive Neuro-fuzzy Inference System

SRI MAWAR SAID¹, MUHAMMAD BACHTIAR NAPPU¹, ANDARINI ASRI², BAYU TRI UTOMO¹

¹Hasanuddin University
Indonesia

²Ujung Pandang State Polytechnic
Indonesia

e-mail: rimawarsaid@gmail.com

(Received: 02.07.2020, revised: 18.01.2021)

28

Abstract: Lightning is one of the causes of transmission disorders and natural phenomena that cannot be avoided. The South Sulawesi region is located close to the equator and has a high lightning density. This condition results in lightning susceptibility of disturbances to electrical system lines, especially in high-voltage airlines and substations. An Adaptive Neuro-Fuzzy Inference System (ANFIS) will show the Root Mean Square Error (RMSE) based on the membership function type. This journal is to predict the value of the transmission tower lightning density using the ANFIS method. The value of the lightning strike density index can later be determined based on ANFIS predictions. Analysis of the value calculation system of structural lightning strikes in the South Sulawesi region of the Sungguminasa-Tallasa route can be categorized as three characteristics lightning density (Nd). The calculation system results for the value of structural lightning struck in the South Sulawesi region and validated between manual calculations and ANFIS with an average percentage of 0.0554%.

Key words: Adaptive Neuro-fuzzy Inference System, lightning density prediction tower, Transmission Line Arrester

1. Introduction

With the growth of technology, electricity demand is increasing, and an improvement must follow this development in the quality of the electricity produced, namely the electric power system's quality and reliability [1]. PT. Perusahaan Listrik Negara (PLN) is a company tasked



9
© 2021. The Author(s). This is an open-access article distributed under the terms of the Creative Commons Attribution-NonCommercial-NoDerivatives License (CC BY-NC-ND4.0, <https://creativecommons.org/licenses/by-nc-nd/4.0/>), which permits use, distribution, and reproduction in any medium, provided that the Article is properly cited, the use is non-commercial, and no modifications or adaptations are made.

with planning, making, and maintaining the electric power system in Indonesia. This company guarantees the electric power system and the quality of electricity to consumers [2].

South Sulawesi is located in the equatorial region with a tropical climate and high humidity [3]. The conditions cause South Sulawesi to have a higher percentage of lightning strikes, and for those strikes to be higher in power. This lightning strike can disrupt the distribution area (transmission and distribution) of electric power. One of the causes of interference among the many disruptions in the electric power system is occurred by lightning strikes.

Several research titles concerning the disorder caused by lightning and arrester placement have been discussed in the past. A lightning strike and the performance of the arrester input it between GI Bone and GI Sinjai [4]. The earthing value is due to a lightning strike in a 150 kV transmission line system, especially the GI transmission line Sungguminasa-GI Tallasa [5]. Research on modeling a 132 kV transmission tower simulated using ATP-EMTP by placing various arresters including, an IEEE model, Pincetti model, and Fernandez model [6], and this research is on how to get determines the lightning structure's strike value accurately using the ANFIS method. ANFIS is used to get the value of the structure's lightning strike on the tower transmission. Then we can determine which towers are included in the critical category on the transmission line. The results of grouping the critical tower is then simulated with an IEEE model arrester to analyze the voltage value impulse that occurs due to lightning in the transmission line. The critical tower is then simulated with an IEEE Model arrester to analyze the voltage value impulse that occurs due to the lightning transmission line.

In this paper, a study will be conducted on obtaining accurate lightning strike density values using the ANFIS method [7, 8]. ANFIS is a method that is often used for predictions and forecasting, with good accuracy. ANFIS is a combination of the backpropagation neural network concept with the fuzzy logic concept. The backpropagation neural network has the advantage of recognizing a data/object based on a set of features that are input to the system. Meanwhile, fuzzy-based systems can be expressed with knowledge in the form of "if-then", which provides the advantage of not requiring mathematical analysis for modeling. Besides, fuzzy systems can also process human reasoning and knowledge-oriented towards qualitative aspects.

ANFIS is an adaptive neural network based on a fuzzy inference system using a hybrid learning procedure. ANFIS can build an input-output mapping based on human knowledge (in the form of fuzzy if-then rules) with the right membership function. Fuzzy conclusion systems that utilize fuzzy if-then rules can model qualitative human knowledge aspects and provide reasoning processes without utilizing appropriate quantitative [9, 10]. In this paper, ANFIS is used to get the value of the structure of lightning density in a transmission tower. ANFIS is used to obtain the value of critical tower lightning density. The tower is in critical condition due to the tower's high lightning strike value, which will be input in the installation of the Transmission Line Arrester (TLA).

2. Transmission system

An electric power system consists of three main parts: a central power plant, transmission line, and distribution system. The transmission line is a link between power centers and distribution systems. The connection between the systems can also lead to other power systems. A distribution system connects all loads separated from each other to the transmission line [11].

2.1. Transmission tower

The electric power channeled through the transmission system generally uses bare wire to rely on-air as a means of insulation between the conductive wire with surrounding objects. The tower is sturdy building construction whose function is to support/span the connecting wire with height and distance sufficient to be safe for humans and the surrounding environment.

There are three different transmission tower models examined. One of them we know is the multistory model designed in [6]. A multistory tower is a composition of parameter distributions with parallel RL [12].

Several tower structures are modeled, in research [13], tower structures at a voltage of 150 kV, as shown in Figure 1.

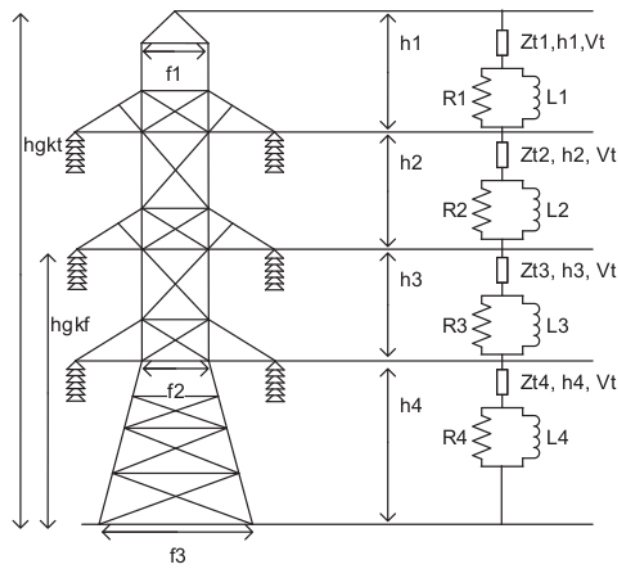

Fig. 1. Tower transmission 150 kV

In this paper, the study has used a 150 kV tower because generally electricity in Indonesia uses a 150 kV tower. The data that has been researched is the data from PLN, and PLN uses a 150 kV tower in the South Sulawesi area. The disadvantage of 150 kV towers is a short distance between them, but one of the advantages of a 150 kV tower is that with a voltage of 150 kV it is still possible to distribute a 400 MVA of power/circuit.

2.2. Transmission line protection from lightning strikes

The conventional protection system commonly used is the cone protection system, which is a simple method of protecting area by using an upright conductor called the 1st method. The second way is the Faraday Cage used for lightning protection of buildings. The third method will

be discussed later by using a rolling ball. For the 4th way, similar to the 3rd way, the drawing model uses a satellite dish method. The cone protection method (existing design) and the rolling sphere method (design improvement) were selected by choosing between several methods.

The existing design (cone protection method) method is used to facilitate the determination of a good protection angle. Determining the magnitude ²⁴ the angle that can provide good protection against interference, especially in lightning strikes, can be seen in Figure 2.

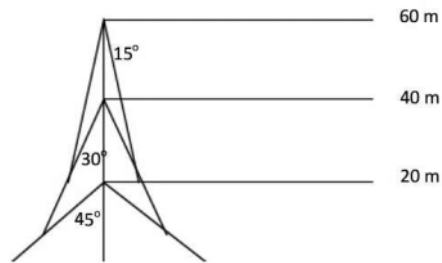

Fig. 2. Cone model lightning protection system

The rolling sphere method is an electrometric concept or rolling ball method connecting the distance of lightning to its peak current. This concept says that an imaginary ball with the lead of the leader at the center of the ball is rolled into a structure. All contact points that hit the surface of the ball will then be struck by lightning. This method is straightforward in determining the design of reliable lightning protection. Figure 3 shows a 150 kV SUTT tower using the rolling sphere method [14, 15].

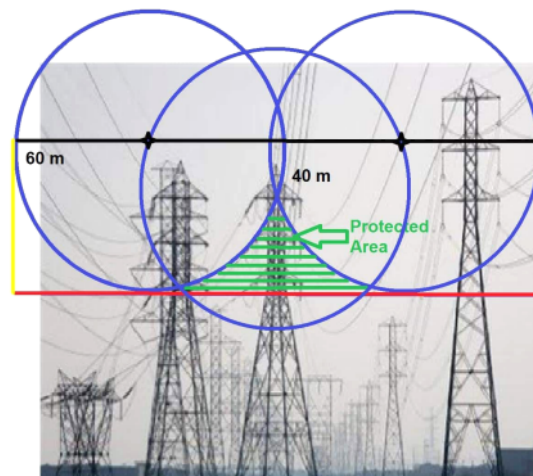

Fig. 3. SUTT tower 150 kV using rolling sphere method

The electrometry concept or the rolling ball method relates the distance of the lightning strike to its peak current. The concept states that an imaginary sphere with the leading tip at the center of the ball rolls into a structure. All points of contact that hit the surface of the ball will then be struck by lightning. This method makes it very easy to determine a reliable lightning protection design. The analysis shows that the height of the high-voltage overhead tower affects the disturbance that occurs due to lightning strikes. To minimize transmission disruption due to lightning strikes, the existing design method (cone protection method) can be used very well for lightning strike protection, while the rolling sphere method is better because it is more reliable in protecting lightning strikes on 150 kV transmission lines.

2.3. Calculation of lightning structure value of lightning tower

An overhead transmission line can form a shadow of electricity on the ground below the transmission line. The width of the electric shadow for a transmission line has been provided [16].

$$hgwkt = hgkt - 1/2(hgkt - hgkf), \quad (1)$$

$$hg = hgkt - 2/3(hgkt - hgwkf). \quad (2)$$

The width of the shadow is formulated:

$$W2 = (b + 4 \cdot hg^{1.09}). \quad (3)$$

The span of tower 2 is the average distance from the tower to tower.

Area of shadows for a transmission span (L):

$$L2 = (\text{span1} + \text{span2})/2. \quad (4)$$

The span protection area ($A2$):

$$A2 = W2 \times L2. \quad (5)$$

The lightning density on the tower (N_d):

$$N_d = 0.15IKL \times A2. \quad (6)$$

Notes: $hgkt$ is the maximum height of the ground wire; $hgkf$ is the maximum height of the phase wire; hg is the height of the tower; $hgwkt$ is the maximum height of the ground wire in spans; b is the distance between ground wires; $W2$ is the protection shadow width; $L2$ is the average tower distance; span 1 is the distance for tower 1; span 2 is the distance for tower 2 or after the tower before; $A2$ is the area of protection; N_d is the value of strikes on the structure (annual strokes).

2.4. Adaptive Neuro-Fuzzy Inference System (ANFIS)

An Adaptive Neuro-Fuzzy Inference System (ANFIS) is an adaptive network based on a fuzzy inference system. Using a hybrid learning procedure, ANFIS can build an input-output mapping based on human knowledge (in the form of fuzzy if-then rules) with an appropriate membership function.

Illustration of the first-order TSK fuzzy inference mechanism with two inputs x and y [10]. The rule base with two fuzzy if-then rules as below:
 Rule 1: if x is A_1 and y is B_1 then $f_1 = p_{1x} + q_{1y} + r_1$.
 Premise consequent
 Rule 2: if x is A_2 and y is B_2 then $f_2 = p_{2x} + q_{2y} + r_2$.
 Premise consequent
 Input: x and y consequent are f .

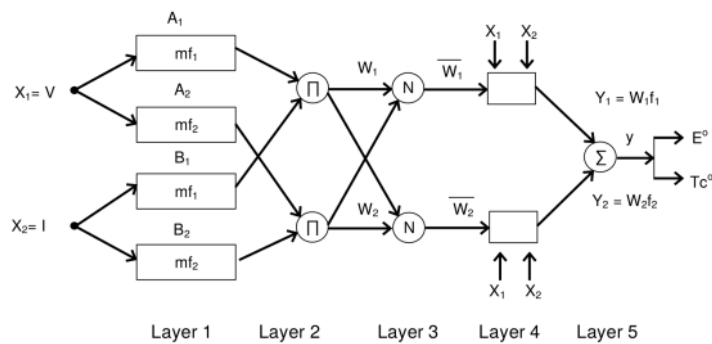

Fig. 4. ANFIS structure for the first-order

The ANFIS architecture consists of five layers, each of which has functions that can be explained as follows.

1. Layer 1: serves as a fuzzy process. The output of node i on Layer 1 is denoted as O_i . So, each node in Layer 1 functions to generate a degree of membership (part of the premise).
2. Layer 2: notated π . Each node in this layer functions to calculate the activation strength (firing strength) on each rule as a product of all incoming inputs.
3. Layer 3: denoted by N . Each node in this layer is non-adaptive which functions only to calculate the ratio between firing strength in the I rule to the total firing strength of all rules.
4. Layer 4: each node in this layer is adaptive w_i , is the output of Layer 3 ($p_{1x} + q_{1y} + r_1$), is the set of parameters in the first-order Sugeno fuzzy model.
5. Layer 5: a single node denoted Σ on this layer functions to aggregate all output from Layer 4.

2.5. Strengths and weakness of ANFIS

The control system will use a system that combines a fuzzy system and an artificial neural network system. This system is known as the neuro-fuzzy system or ANFIS.

The basis of the integration are the advantages and disadvantages of each system. Artificial neural networks can recognize the system through a learning process to improve adaptive parameters. The advantage of fuzzy inference systems is that they can translate knowledge from experts in rules. Still, it usually takes a long time to determine the membership function. Therefore it takes learning techniques from artificial neural networks to automate the process so that it can

reduce search time; this causes the ANFIS method to be very well applied in various fields. The weakness of this system is the complexity of the structure. The fuzzy system has a concept similar to the concept of human thinking.

The combination of the two will complement each other's strengths and weaknesses. Several studies have been carried out to see the comparison between ANFIS and a Fuzzy Logic Controller (FLC), the ANFIS results are better than those of an LFC [17, 18]. There are also studies on the comparison of ANFIS and an Artificial Neural Network (ANN). The results of this study indicate ANFIS is better than an ANN [19]. Other studies also compared ANFIS with some artificial intelligence such as a Firefly Algorithm (FA), Particle Swarm Optimization (PSO), and Imperialist Competitive Algorithm (ICA). The results of this study indicate that ANFIS is better than artificial intelligence such as a Firefly Algorithm (FA), Particle Swarm Optimization (PSO), and Imperialist Competitive Algorithm (ICA) [20].

3. Simulation result and discussion

Processing calculation data into artificial intelligence makes it easier to get the value of the tower's lightning strike density [21]. The artificial intelligence used is the Adaptive Neuro-Fuzzy Inference System (ANFIS).

The results of the calculation of the lightning strike value in the form of whitehead then become input data for data processing in ANFIS, Process Stages of Simulation:

- a. Data Load Phase (Data Entering Phase)
- b. The Generate FIS Phase (Generating FIS Stage)
- c. FIS Training Stage (FIS Learning Stage)
- d. FIS Test Stage (FIS Validation Stage).

3.1. Learning process model (training)

Based on the comparison of the RMSE (Root Mean Square Error) learning process (training) in Table 1, the most optimal method for this case is:

- a. Learning algorithm: hybrid method
- b. Type of membership function (MF): *psigmf*
- c. Epoch: 50
- d. Error tolerance: 0
- e. Input parameters: (3 3 3 3) *f*.

It consists of 81 rules. The method is taken from the lowest error rate.

Figure 5 shows ANFIS neurons consisting of 4 inputs, one output, and 81 rules.

To make it easier to see the rule, we can see the surface viewer in Figure 7 through Figure 6 to observe the relationship between the four inputs and the output of ANFIS. Figure 6 shows four inputs (*hgkt*, *hgkf*, *b*, and *span*) and one output (*Nd*). Dataanfisrev is a training process in ANFIS processing to produce the output of ANFIS.

Figure 7 shows the surface viewer of *hgkt*, *hgkf*, and *Nd*, where the X-axis is *hgkt*, Y-axis is *hgkf*, and the Z-axis is *Nd*.

Figure 8 shows the surface viewer of *hgkt*, *b*, and *Nd*, where the X-axis is *hgkt*, the Y-axis is *b*, and the Z-axis is *Nd*.

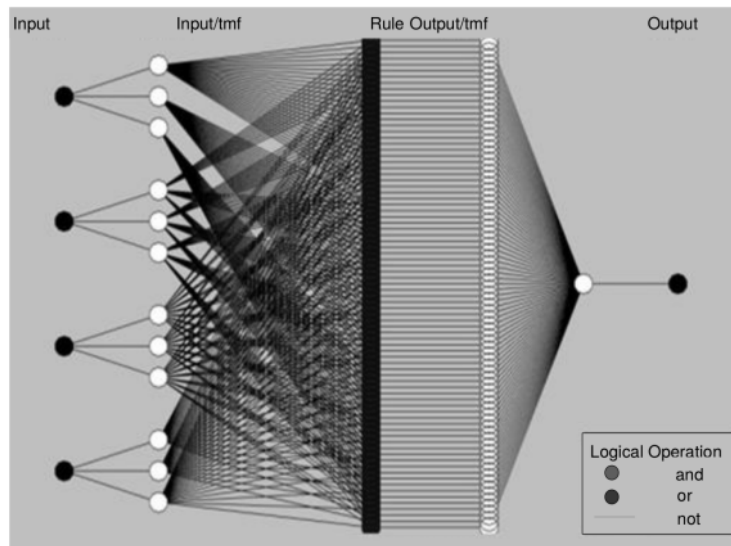

Fig. 5. Learning process model (training)

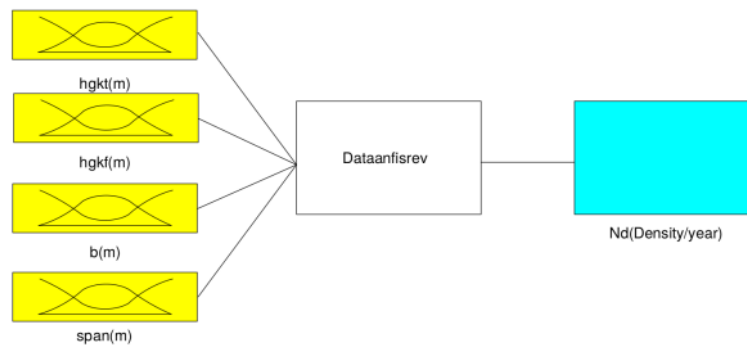

Fig. 6. FIS learning editor (training)

Figure 9 shows the surface viewer of $hgkt$, $span$, and Nd_2 , where the X -axis is $hgkt_2$, Y -axis is the span distance, and the Z -axis is Nd .

Figure 10 shows the surface viewer of $hgkf$, b , and Nd , where the X -axis is $hgkf_2$, the Y -axis is b_2 and the Z -axis is Nd .

Figure 11 shows the surface viewer of $hgkf$, $span$ distance, and Nd_2 , where the X -axis is $hgkf_2$, the Y -axis is the span distance, and the Z -axis is Nd .

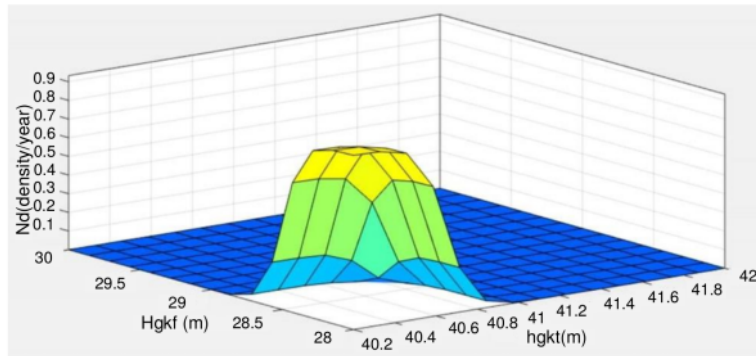

Fig. 7. Surface viewer between $hgkt$ and $hgkf$

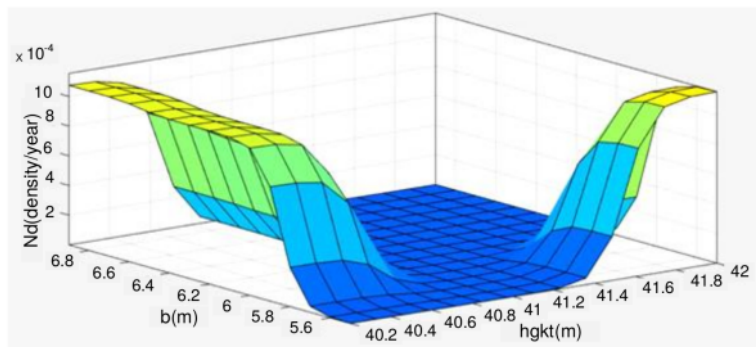

Fig. 8. Surface viewer between $hgkt$ and b

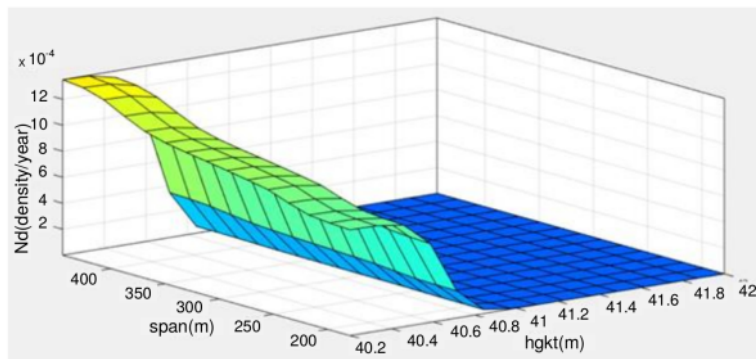
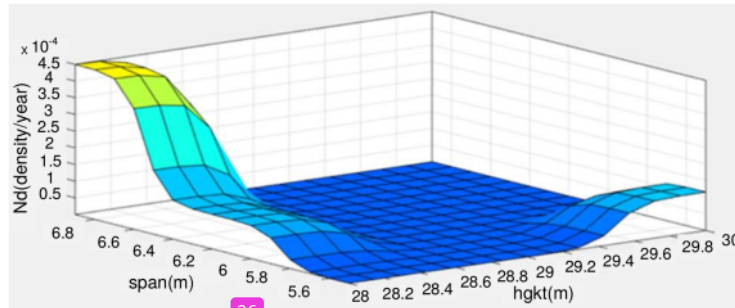

Fig. 9. Surface viewer $hgkt$ and span distance



26 Fig. 10. Surface viewer $hgkf$ and b

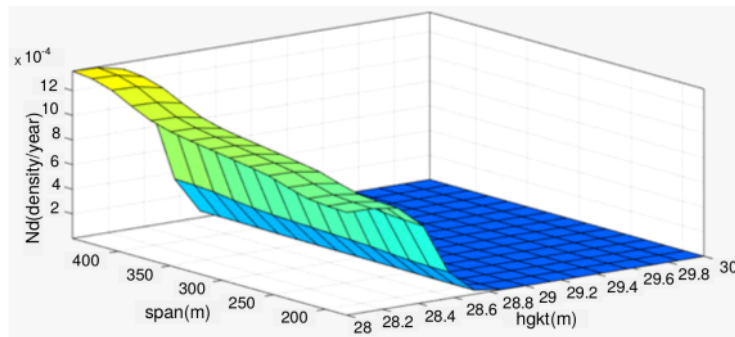

Fig. 11. Surface viewer $hgkf$ and span distance

Figure 12 shows a surface viewer of b , span distance, and Nd_2 , where the X-axis is b_2 , the Y-axis is the span distance, and Z-axis is Nd .

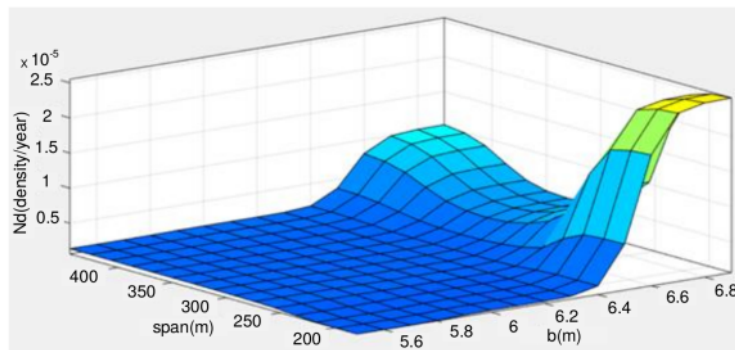

Fig. 12. Surface viewer span distance and b

3.2. The results of ANFIS

Table 1 compares RMSE for two methods, Hybrid and Backpropagation, in the learning process (training) and the validation process (testing). The lowest RMSE in the learning process is 0.07588 for training data and 0.07588 for testing with *dsignmf* and *psignmf* membership functions.

Table 1. RMSE comparison of Hybrid and Backpropagation methods

Membership Function	RMSE (Root Mean Square Error)			
	Data Training		Data Testing	
	Hybrid	Back-propagation	Hybrid	Back-propagation
<i>trimf</i>	0.07589	0.48271	0.07589	0.47364
<i>trapmf</i>	0.07886	0.46583	0.07886	0.45786
<i>gbellmf</i>	0.07597	0.51851	0.07597	0.50895
<i>gaussmf</i>	0.07592	0.49996	0.07592	0.49049
<i>gauss2mf</i>	0.07782	0.46550	0.07782	0.45746
<i>pimf</i>	0.07989	0.46534	0.07989	0.45754
<i>dsignmf</i>	0.07588	0.44199	0.07588	0.43343
<i>psignmf</i>	0.07588	0.44181	0.07588	0.43325

From the results obtained through ANFIS, the results are loading and testing. ANFIS can predict through the lightning density values that often appear when a lightning strike occurs based on the tower input data processed by ANFIS.

3.3. GUI (graphical user interface)

The display of the model of determining the value of the structure of lightning strikes based on adaptive neuro-fuzzy inference systems uses the Matlab software, with lightning strike value output. The rule used is from the ANFIS rule with the AND logic function. The display of the lightning strike value structure based on the adaptive neuro-fuzz inference system is shown in Figure 13.

**Calculation of
Lightning Strike Density Value
at The Tower Transmission South Sulawesi**

INPUT		OUTPUT	
Hght (m)	42	Nd	1.04829
Hgtf (m)	30	Categories LOW: $Nd < 0.90$ / year MEDIUM: $0.91 \leq Nd \leq 0.94$ / year HIGH: $0.95 \leq Nd > 1.0$ / year	
b (m)	5.5		
Span (m)	317.15		
PROCESS		EXIT	

Fig. 13. Display GUI prediction of lightning strike tower value

4. Conclusions

This paper analysis allowed one to conclude that several things are needed to determine the value of the lightning strike structure of the South Sulawesi region:

1. The result shows ANFIS simulation with a hybrid algorithm and backpropagation algorithm hybrid. The backpropagation algorithm with *trimf*, *trmf*, *gbellmf*, and *gaussmf* functions shows the comparison of the RMSE for two methods, namely Hybrid and Backpropagation, in the learning process (training) and the validation process (testing). The lowest RMSE in the learning process is 0.07588 with the *gaussmf* membership function for training and testing data.
2. The calculation system results for the value of structural lightning struck in the South Sulawesi region are shown. They validated manual calculations and ANFIS with an average percentage of 0.0554%.
3. Based on this research, we can calculate the value of lightning density (Nd) by using ANFIS, which is programmed in a GUI. This GUI makes it easy to find out the lightning density (Nd) value on the tower.

References

- [1] Utomo B.T., Nappu M.B., Said S.M., Arief A., *The Placement of the Transmission Lightning Arrester (TLA) at 150 kV Network using Fuzzy Logic*, in 2018 10th International Conference on Information Technology and Electrical Engineering (ICITEE), pp. 347–352 (2018).
- [2] Rawi I.M., Kadir M.Z.A.A., Azis N., *Lightning study and experience on the first 500kV transmission line arrester in Malaysia*, in 2014 International Conference on Lightning Protection (ICLP), pp. 1106–1109 (2014), DOI: [10.1109/ICLP.2014.6973289](https://doi.org/10.1109/ICLP.2014.6973289).

- [3] Gassing, *Analisis Sistem Proteksi Petir (Lighting Performance) Pada Sutt 150 kV Sistem Sulawesi Selatan*, vol. 6, pp. 978–979 (2012).
- [4] Apriyadi M., Manjang S., Nappu M.B., *Tegangan Impuls Dan Arus Transien Jaringan Transmisi 150 kV Sinjai-Bone Akibat Sambaran Petir Menggunakan ATPDraw*, *Jurnal Sains dan Teknologi*, vol. 3, no. 2, pp. 156–164 (2014).
- [5] Lembang N., Manjang S., Kitta I., *Efek Penurunan Tahanan Pembumian Tower 150 kV terhadap Sistem Penyaluran Petir*, *J. Penelit. Enj.*, vol. 21, no. 2, pp. 7–15 (2017).
- [6] Islam M.Z., Rashed M.R., Yusuf M.S.U., *ATP-EMTP modeling and performance test of different type lightning arrester on 132kv overhead transmission tower*, in 2017 3rd International Conference on Electrical Information and Communication Technology (EICT), pp. 1–6 (2017).
- [7] Houari K., Hartani T., Remini B., Lefkir A., Abda L., Heddam S., *A hybrid model for modelling the salinity of the Tafna River in Algeria*, *J. Water L. Dev.*, vol. 40, no. 1, pp. 127–135 (2019).
- [8] Gubán M., Kása R., Takács D., Avornicului M., *Trends of using artificial intelligence in measuring innovation potential*, *Manag. Prod. Eng. Rev.*, vol. 10 (2019).
- [9] Jang J.S.R., *MATLAB: Fuzzy logic toolbox user's guide: Version 1* (1997).
- [10] Said S.M., Latief S., *Determination Of Sensorless Input Parameters Of Solar Panel With Adaptive Neuro-Fuzzy Inference System (Anfis) Methods*, Indonesia (2018).
- [11] Marsudi D., *Operasi Sistem Tenaga Listrik* (2006).
- [12] Ishii M. et al., *Multistory transmission tower model for lightning surge analysis*, *IEEE Trans. Power Deliv.*, vol. 6, no. 3, pp. 1327–1335 (1991).
- [13] Ito T., Ueda T., Watanabe H., Funabashi T., Ametani A., *Lightning flashovers on 77-kV systems: observed voltage bias effects and analysis*, *IEEE Trans. Power Deliv.*, vol. 18, no. 2, pp. 545–550 (2003).
- [14] Correia M.T., Festas J., Milheiras H., Felizardo N., Fernandez M., Sousa J., *Methodologies for evaluating the lightning performance of transmission lines*, ICOLIM (1998).
- [15] Oktaviani W.A., Hati I.P., *Efektifitas Perlindungan Kawat Tanah Jaringan SUTM 20 kV Gardu Induk Boom Baru Palembang*, *PROtek J. Ilm. Tek. Elektro*, vol. 6, no. 2, pp. 90–95 (2019).
- [16] Nugroho A., Syakur A., *Penentuan Lokasi Pemasangan Lightning Masts Pada Menara Transmisi Untuk Mengurangi Kegagalan Perlindungan Akibat Sambaran Petir*, *Transmisi*, vol. 7, no. 1, pp. 31–36 (2005).
- [17] Simon R., Geetha A., *Comparison on the performance of Induction motor control using fuzzy and ANFIS controllers*, in 2013 IEEE International Conference ON Emerging Trends in Computing, Communication and Nanotechnology (ICECCN), pp. 491–495 (2013).
- [18] Lincy L.M., Senthil K.R., *Comparison Analysis of Fuzzy Logic and ANFIS Controller for Mitigation of Harmonics*, *Proc. 4th Int. Conf. Electr. Energy Syst. ICEES 2018*, pp. 578–583 (2018).
- [19] Rahman M.M.A., Rahim A., *Performance evaluation of ANN and ANFIS based wind speed sensorless MPPT controller*, in 2016 5th International Conference on Informatics, Electronics and Vision (ICIEV), pp. 542–546 (2016).
- [20] Ali M., Nurohmah H., Raikhani A., Sopian H., Sutantra N., *Combined ANFIS method with FA, PSO, and ICA as Steering Control Optimization on Electric Car*, in 2018 Electrical Power, Electronics, Communications, Controls and Informatics Seminar (EECCIS), pp. 299–304 (2018).
- [21] Aniserowicz K., *Analytical calculations of surges caused by direct lightning strike to underground intrusion detection system*, *Bull. Polish Acad. Sci. Tech. Sci.*, vol. 67, no. 2 (2019).

ORIGINALITY REPORT

18%

SIMILARITY INDEX

13%

INTERNET SOURCES

15%

PUBLICATIONS

10%

STUDENT PAPERS

PRIMARY SOURCES

1	www.ijert.org Internet Source	2%
2	Renlong Hang, Qingshan Liu. "Dimensionality Reduction of Hyperspectral Image Using Spatial Regularized Local Graph Discriminant Embedding", IEEE Journal of Selected Topics in Applied Earth Observations and Remote Sensing, 2018 Publication	1%
3	search.datacite.org Internet Source	1%
4	www.jurnalteknik.unisla.ac.id Internet Source	1%
5	api.intechopen.com Internet Source	1%
6	Abduh Muhammad, Yul Y. Nazaruddin, Parsaulian I. Siregar. "Design of Nonlinear Adaptive-Predictive Control System with ANFIS Modeling for Urea Plant Reactor Unit", 2019 6th International Conference on	1%

Instrumentation, Control, and Automation (ICA), 2019

Publication

7	repo.lib.tokushima-u.ac.jp Internet Source	1 %
8	H. Wei-Gang. "Lightning Performance of 500-kV Double-Circuit Line Schemes for the Three-Gorge Project", IEEE Transactions on Power Delivery, 2006 Publication	1 %
9	Submitted to Ngee Ann Polytechnic Student Paper	1 %
10	www.liophant.org Internet Source	1 %
11	Dimas Okky Anggriawan, Eka Prasetyono, Fikri Fahrissi, Anang Budikarso, Anang Tjahjono, Hardefa Rizky Putu Rogonondo. "Digital Overcurrent Relay Implementation With Non-Standard Inverse Curve Modelling Using Adaptive Neuro Fuzzy Inference System", 2019 International Conference of Artificial Intelligence and Information Technology (ICAIT), 2019 Publication	1 %
12	Md. Zoyheroul Islam, Md. Rasheduzzaman Rashed, Md. Salah Uddin Yusuf. "ATP-EMTP modeling and performance test of different	1 %

type lightning arrester on 132kv overhead transmission tower", 2017 3rd International Conference on Electrical Information and Communication Technology (EICT), 2017

Publication

13

Submitted to Netaji Subhas Institute of Technology

Student Paper

<1 %

14

jurnalteknik.unisla.ac.id

Internet Source

<1 %

15

Submitted to University of Glamorgan

Student Paper

<1 %

16

ijpsat.ijsh-t-journals.org

Internet Source

<1 %

17

ethesisarchive.library.tu.ac.th

Internet Source

<1 %

18

www.wseas.us

Internet Source

<1 %

19

e-space.mmu.ac.uk

Internet Source

<1 %

20

Bayu Tri Utomo, Muhammad Bachtiar Nappu, Sri Mawar Said, Ardiaty Arief. "The Placement of the Transmission Lightning Arrester (TLA) at 150 kV Network using Fuzzy Logic", 2018 10th International Conference on Information

<1 %

Technology and Electrical Engineering (ICITEE), 2018

Publication

21

sciencepubco.com

Internet Source

<1 %

22

Issam Hayder Alsakini, Muhanad D. Almawlawe, Israa Amer Dahham. "Controlling Switched Dc-Dc Converter Using ANFIS in Comparison with PID Controller", IOP Conference Series: Materials Science and Engineering, 2020

Publication

<1 %

23

repository.ub.ac.id

Internet Source

<1 %

24

Agung Nugroho, Omar Abouzeid, Hermawan, Abdul Syakur, Karnoto, Mochammad Facta. "An Investigation of Direct Grounding System Effect on Modeling of Lightning and Tower in Transmission Line", 2018 5th International Conference on Information Technology, Computer, and Electrical Engineering (ICITACEE), 2018

Publication

<1 %

25

Atik Apprinda Paramita, Prima Kristalina, Bima Sena Bayu Dewantara. "Performance Enhancement of Multi-Camera Handoff Scheme using ANFIS Method", 2021

<1 %

International Electronics Symposium (IES), 2021

Publication

26

Shilpa Srivastava, Millie Pant, Namrata Agrawal. "Psychology of adolescents: a fuzzy logic analysis", International Journal of System Assurance Engineering and Management, 2016

Publication

<1 %

27

coek.info

Internet Source

<1 %

28

pt.scribd.com

Internet Source

<1 %

29

real-j.mtak.hu

Internet Source

<1 %

30

www.scribd.com

Internet Source

<1 %

Exclude quotes On

Exclude matches < 5 words

Exclude bibliography On